

AeroSplice® Connectors Series

Wire-to-Wire Connecting Solution

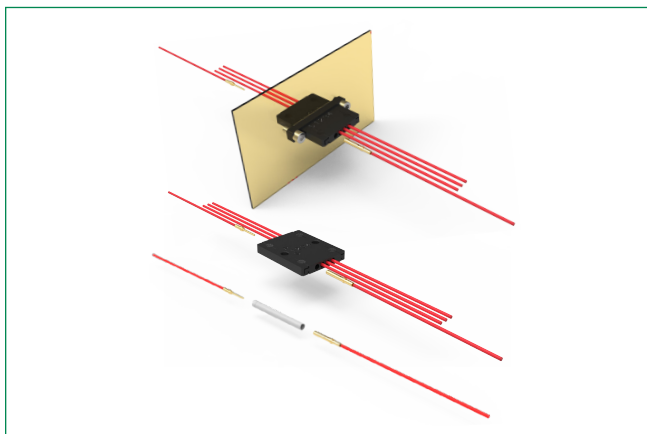

Specifications

Quality Level	Exceeds the requirement of MIL-DTL-24308
Process: Contact Crimping and Cable Insertion	Cables crimping onto contacts with standard Crimping tool M22520/2-01 and locator M22520/2-08 (to be ordered separately). Wires cable installed by the end user.
Process: Contact and Cable Insertion and Extraction	Tool M81969/39-01 with plastic tip is available to insert and extract the AeroSplice connectors from the contact (1 extract tool is delivered per bag).
Packaging and Traceability	AeroSplice connectors 1-way: 50 pcs per bag. One insertion/extraction tool (M81969/39-01) is delivered per bag.
	AeroSplice connectors 4-way: Individual packaging. One insertion/extraction tool (M81969/39-01) is delivered per bag. Traceability associated as per MIL-DTL-24308 requirement.

Electrical & Mechanical Characteristics

Characteristic	Specification
Working Voltage - 1 way (sea level)	300 Vrms
Working Voltage - 4 way (sea level)	250 Vrms
Rated Current	7.5 A
Contact Resistance	5 mΩ (rated current)
Insulation Resistance at 500 V DC	5000 MΩ min
Voltage Proof - 1 way	1250 Vrms / 2.0mA
Voltage Proof - 4 ways	1000 Vrms / 2.0mA
Temperature Range	-55°C to 125°C
Contact Retention Force	40 N min

Description

AeroSplice® connectors, designed for ease of use, enable secure wire-to-wire connection using removable contact technology. They offer a reliable and efficient alternative to the traditional hand splicing process by replacing it with a standardized method that saves time and effort. AeroSplice connectors support a range of wire gauges, reducing costs and ensuring only the necessary wires are used. Engineered to exceed MIL-DTL-24308 quality standards, they are ideal for various wiring applications in aerospace and defense.

Features & Benefits

- Exceeds MIL-DTL-24308 specifications, ensuring it is suited for demanding aerospace and military applications
- Eliminates traditional manual splicing, enabling fast and consistent wiring assembly that can reduce installation and inspection time by more than 60%
- The reconnect-able design with removable crimp contacts allows for easy repairs and maintenance
- Engineered to withstand high vibration, extreme temperatures, and harsh condition
- Supports a wide range of standard in place of common wire gauges (AWG20 to AWG28), offering flexibility for diverse wiring configurations

Applications

- Aircraft systems
- Defense equipment
- Mission-Critical Infrastructure
- MRO (Maintenance, Repair, and Overhaul)
- Industrial systems

Materials & Finishes

Component	Material	Finish
Insulator	PEEK	UL 94 V-0 flammability, 1-way - natural color 4-way - black color
Retention Clip	Beryllium Copper Alloy	Raw material
Socket Contacts	Copper Alloy	1.27 μm Gold over Copper underlay
Pin Contacts	Copper Alloy	1.27 μm Gold over Copper underlay

AeroSplice® Connectors Series

Wire-to-Wire Connecting Solution

AeroSplice Connectors 1-Way Wire-to-Wire Connecting Solution



Description

Part #	Description
C115376-0000	AEROSPLICE-1W-FR059

Dimensions and Mass

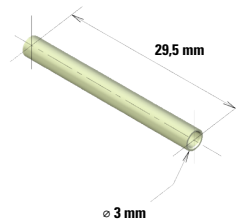

Mass = 0.2 grams

AeroSplice Connectors 4-Way Radial Fixing Variant, Stackable

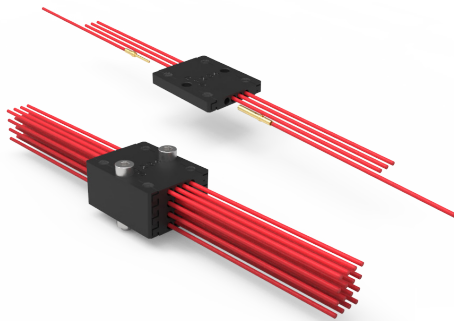

Note: Stacking configuration: 16 conductors

Description

Part #	Description
C115376-0001	AEROSPLICE-4W-R-FR059

Dimensions and Mass

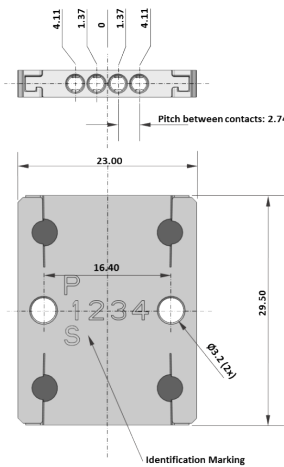

Mass = 3.5 grams

Torque value for Fixing screws

M3	1.18 N.m ±0.02
M2	0.33 N.m ±0.02
2-56 UNC-2A	0.46 N.m ±0.02

AeroSplice® Connectors Series

Wire-to-Wire Connecting Solution

AeroSplice Connectors 4-Way Axial Fixing Variant, Panel Mount

Description

Part #	Description
C115376-0002	AEROSPLICE-4W-A-FR059

Dimensions and Mass

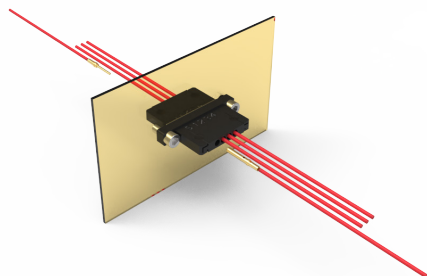

Panel Cut-Out Profile

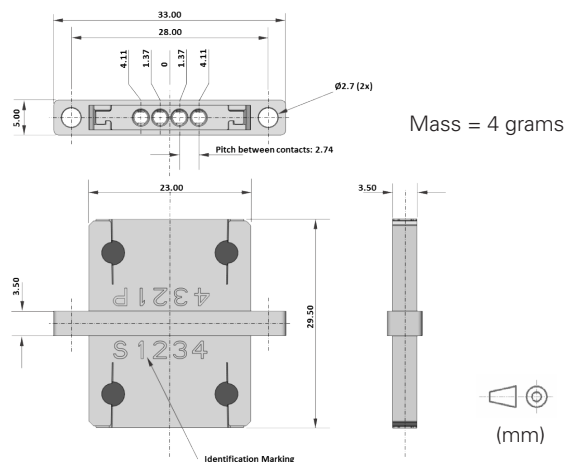
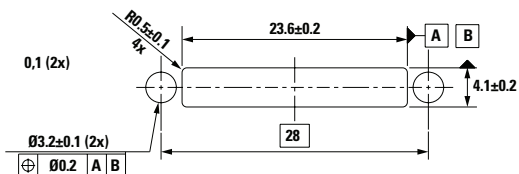

M2	0.33 N.m ±0.02
2-56 UNC-2A	0.46 N.m ±0.02

Usage Explanation Wire-to-Wire Connecting Solution

- Purpose: To crimp pin and socket removable crimp contact, certified to AS39029.
- Manually install the contacts into AeroSplice connectors or use the insertion/extraction tool (M81969/39-01).
- For the installation of contacts wired with AWG26/28 (without shrinkable tube), the insertion/extraction tool (M81969/39-01) is mandatory.
- If using different wire sizes on each contact side, insert the contact with the smallest wire size first to perform the retention test by pushing them together.

AeroSplice® Connectors Series

Wire-to-Wire Connecting Solution

Contact Sizes & Part Numbers

Part Number	Contact Type	Size	Wire Size	Description
C330-5291-037B	Contact Pin	20/20	AWG20, AWG22, AWG24	AS39029/64-369
C330-8997-101D	Contact Pin	20/26	AWG26, AWG28	330-8997-101-FR022
C031-1007-042B	Contact Socket	20/20	AWG20, AWG22, AWG24	AS39029/63-368
C031-8997-101D	Contact Socket	20/26	AWG26, AWG28	031-8997-101-FR022

Note: Measurements in Millimeters

C330-5291-037B Dimensions

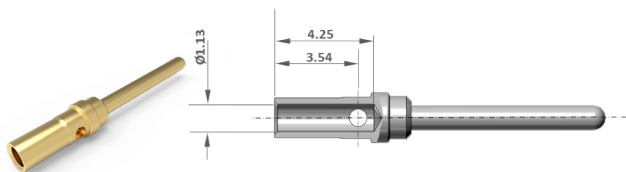

C330-8997-101D Dimensions

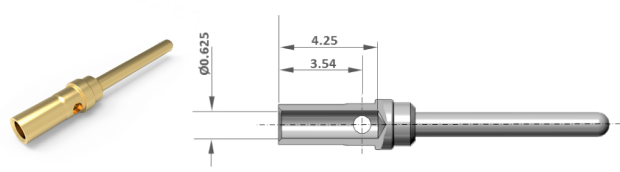

C031-1007-042B Dimensions

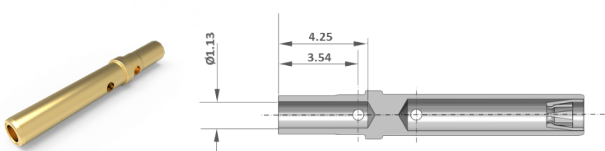

C031-8997-101D Dimensions

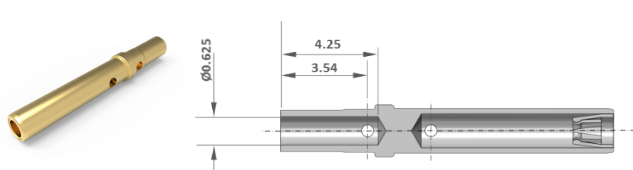

Note: Measurements in Millimeters

Accessories & Tools

Accessory Image	Accessory Name	Description	Part #
	Crimping Tool	M22520/2-01	C995-0001-584
	Locator	M22520/2-08	C995-0001-604
	Insertion/Extraction Tool	M81969/39-01	C980-2000-426
 6-32 UNC-2A Compatible with OCETA OCE8	Contact Probe for Retention Tool Push Test ¹	SPLICE-TOOL-RETENTION-01	C115366-2852
 6-32 UNC-2A Compatible with OCETA OCE8	Contact Probe for Retention Tool Pull Test ²	SPLICE-TOOL-RETENTION-02	C115366-2853

Note:

1. Push test recommended value: All wire size: 20N max
2. Pull test recommended value: AWG20, 22, 24, 26: 20N max AWG28: 10N max

Disclaimer Notice - Information furnished is believed to be accurate and reliable. However, users should independently evaluate the suitability of and test each product selected for their own applications. Littelfuse products are not designed for, and may not be used in, all applications. Read complete Disclaimer Notice at <http://www.littelfuse.com/disclaimer-electronics>.