

KSC8 Series

Sealed Tactile Switch for SMT 6.2 x 6.2 mm, with 4.9 mm Height Hard Actuator



Description

“The KSC8 series of sealed tactile switches for SMT are IP67 rated, 4.9 mm high momentary action tactile switches, featuring a hard actuator. The switches are available with a variety of operating forces depending on the model and have a lifespan of 300,000 cycles.

The KSC8 series are designed to give users a positive adaptable tactile feeling, perfect for industrial, consumer and automation applications.

Features & Benefits

- Positive adaptable tactile feeling
- Hard actuator 4.9mm high
- IP67
- Compatible with lead free reflow soldering process of SMT devices
- RoHS and REACH compliant

Specifications

| | |
|----------------------------|---|
| Function | Momentary action |
| Contact Arrangement | 1 make contact = SPST, N.O. |
| Terminals | J bend & Gullwing type for SMT |
| Sealing | IP67 |
| Packaging | Switches delivered on continuous tape & reels of 1,000 pieces. Dimensions according to EIA RS-481/ IEC 60286-3 standard External diameter 330 ± 2 mm |

Applications

- Industrial electronics
- Consumer products
- Transportation
- Medical

J Dimensions (mm)

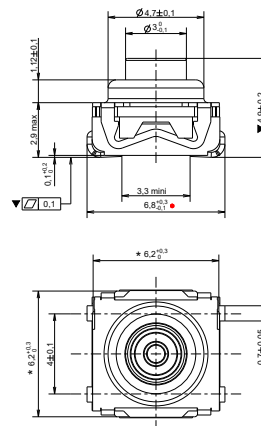

G Dimensions (mm)

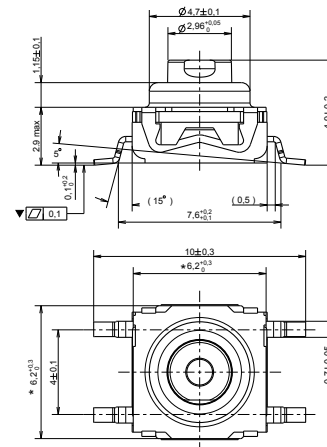

KSC8 Series

Sealed Tactile Switch for SMT 6.2 x 6.2 mm,
with 4.9 mm Height Hard Actuator



Mechanical Characteristics

| Part # | Operating Force FA (Newtons) | Operating Life (operations) | Travel (mm) |
|-----------|------------------------------|-----------------------------|-------------|
| KSC821 | 3.15 ± 0.75 | 300,000 | 0.65 ± 0.2 |
| KSC821 OL | 1.7 ± 0.5 | 300,000 | 0.4 ± 0.2 |
| KSC831 OL | 2.55 ± 0.65 | 300,000 | 0.4 ± 0.2 |
| KSC841 OL | 3.4 ± 0.85 | 300,000 | 0.4 ± 0.2 |

Soldering Profile

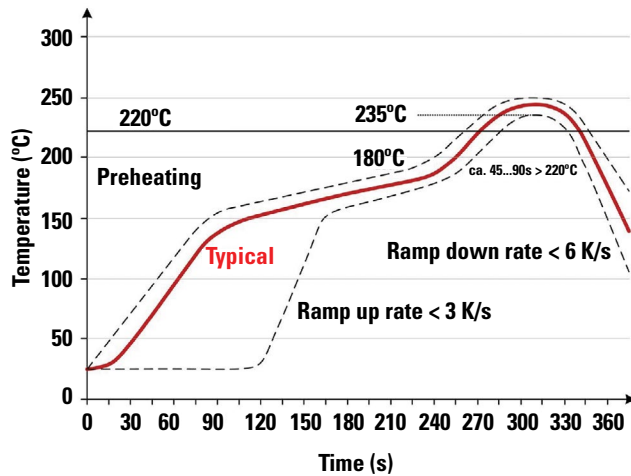

Note: Up to 2 reflow cycles in accordance with the above temperature profile

Soldering process: Depending on the application, this component is suited to the following methods:

- Terminals being silver or gold plated over a nickel barrier, the use of slightly activated flux is suitable.
- Lead free soldering process in accordance with the definition on the left.

J Terminations (mm)

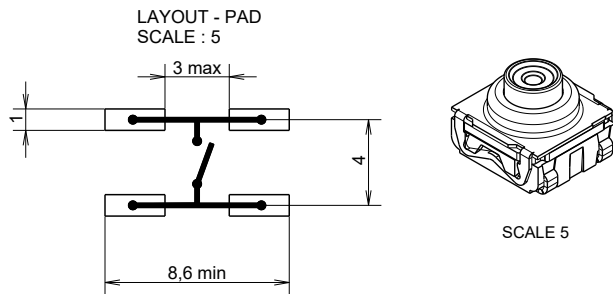

G Terminations (mm)

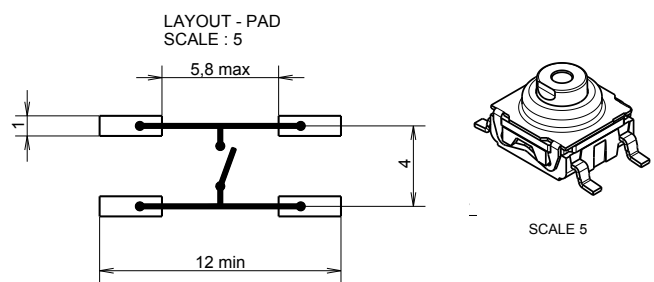

KSC8 Series

Sealed Tactile Switch for SMT 6.2 x 6.2 mm, with 4.9 mm Height Hard Actuator

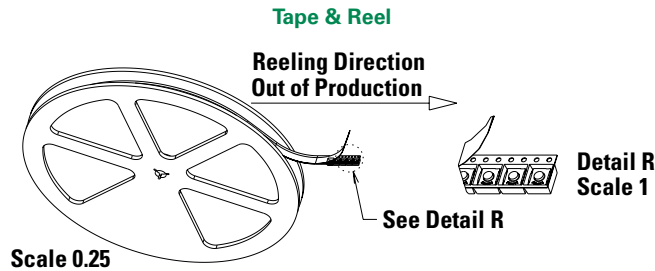

Packaging Details

| | |
|------------------------------|---------------------------------------|
| Type | Tape & reel |
| Number of Parts in Packaging | 2,000 |
| Other Information | Tape and reel per EIA 481 |
| Transport Conditions | According to specification NF H00-060 |

Ordering Number

Our easy build-a-switch concept allows you to mix and match options to create the switch you need. To order, select desired option from each category and place it in the appropriate box. For any part number different from those listed below, please consult your local representative.

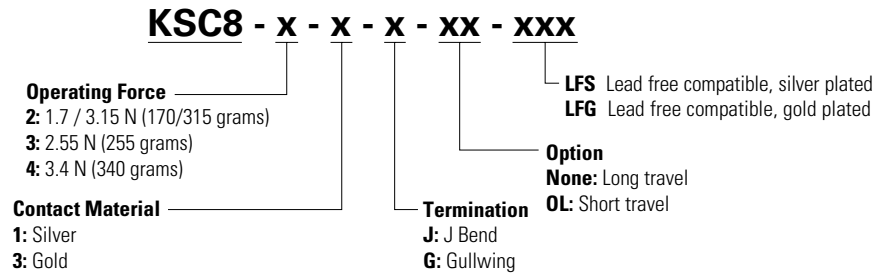

Liability Limitation

This datasheet does not provide enough information for applications that require a certain level of quality or safety such as automotive, medical systems, or safety equipment. Please contact customer service for the contractual specification package.

Disclaimer Notice - Information furnished is believed to be accurate and reliable. However, users should independently evaluate the suitability of and test each product selected for their own applications. Littelfuse products are not designed for, and may not be used in, all applications. Read complete Disclaimer Notice at <http://www.littelfuse.com/disclaimer-electronics>.